

2

SERIES



2 SERIES

2 Series Valves

High Capacity Solenoid Valves (17 Watts)

General Specifications:

Aluminum or brass body with stainless steel internal parts—compatible with common media including air, inert gases, hydraulic fluids, petroleum products, etc.

Maximum Operating Pressure Differential:
up to 750 psi (51.7 bar)

Orifice Diameters: Body orifice—1/16" to 3/8"
Stop orifice—3/32" to 3/16"

Response Time: 20 to 25 milliseconds

Power Consumption: 17 watt continuous duty

Vacuum: Special to 10 microns

Port Size: 1/4" NPT and 3/8" NPT

Housing: Grommet, 1/2" conduit

Seal Material: Buna N standard, Viton, EPDM, others optional

Leakage: Bubble tight (1 x 10⁻⁵ cc/sec.)

Coil Type: Continuous Rating 17 watt—Class "B"
(130°C) non-molded standard

Standard Voltages: 24V/50-60 Hz, 120V/50-60 Hz,
240V/50-60 Hz, 12, 24 VDC. Other voltages and wattages available upon request

Media Temperature Limitations:
Standard; -40°F to 180°F (-40°C to 82°C)

Weight: Approximately 1.7 lbs. (Aluminum Body)

Leadwire: 18 AWG, 18 (457) inches long standard

Body Size: 2"

2 Series Solenoid Valves:

These rugged, direct acting valves offer the largest flow capacity, and are available with up to 3/8" ports and 1/4" orifices. Series 2 Solenoid Valves feature a very powerful 17-watt coil. These valves are designed to operate under high pressure with a high flow rate. Typical applications include use with packaging equipment, colorant mixing, blow molding, heat exchangers and industrial washing equipment.



Valve Model Number Matrix

2 WAYS	22 FAMILY	4 FUNCTION	8 COIL TYPE	3 PORT SIZE	N PORT TYPE	B BODY MATERIAL	A SEAL MATERIALS	4 ORIFICE SIZE	J WATTAGE	2 VOLTAGE	
2-Way	"2" Series	3 2-Way Normally Closed	Non-Molded Class "B" with 18" leads	2 1/4"	N NPT Female	B Brass	A Buna	4 1/16" (1.6)	J 17	1 120/60	
3-Way		3 3-Way Normally Closed Line Connect		0 with 18" Leads/ Conduit	3 3/8"	D Defined Elsewhere	O Without Body	E EPDM	6 3/32" (2.4)		2 24/60
		4 Normally Open		8 with 18" Leads/ Conduit	Q Defined Elsewhere		V Viton	8 1/8" (3.2)		3 240/60	
		5 Directional Control	Molded Class "B" with 18" Leads					9 5/32" (4.0)		4 6 VDC	
		7 Multi-Purpose		1 with 18" Leads				A 3/16" (4.8)		5 12 VDC	
				M with 18" Leads/ Conduit				C 1/4" (6.4)		6 24 VDC	
							D 5/16" (8.0)				
							E 3/8" (9.5)				

Dimensions

2-Way Normally Closed Conduit Housing

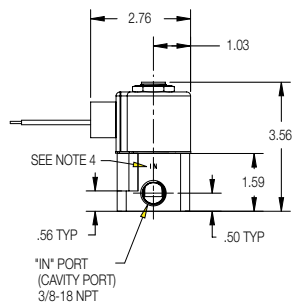

2-Way Normally Closed Grommet Housing

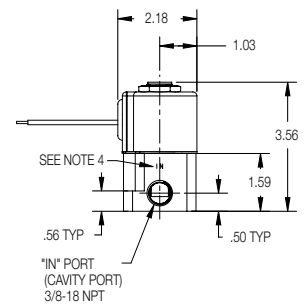

2-Way Normally Open Grommet Housing

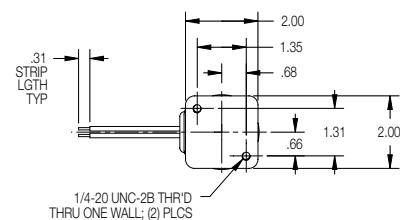
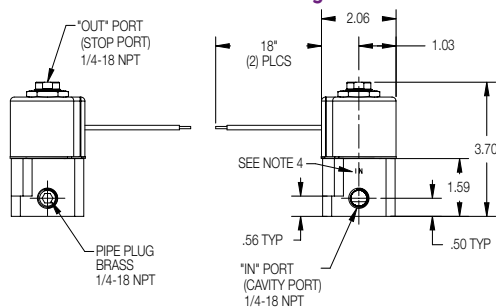

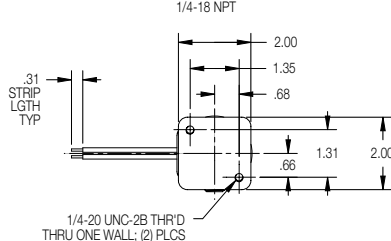
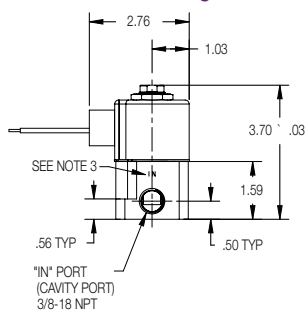

3-Way Line Connect Conduit Housing

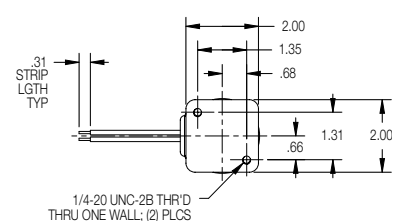
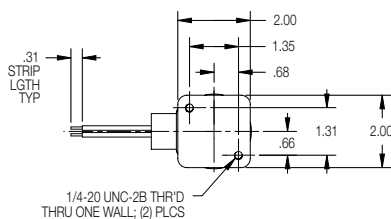
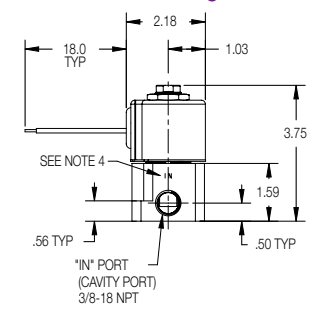

3-Way Line Connect Grommet Housing

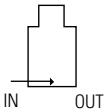
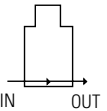
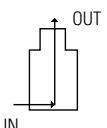
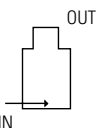
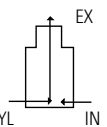
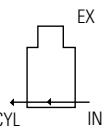
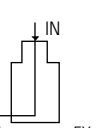
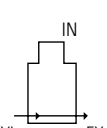

Maximum Operating Pressure Differential (PSI)

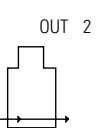
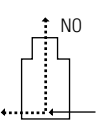
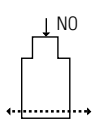
2-Way AC Pressure Ratings		Orifice Diameter		C _v Factor		Maximum Operating Pressure Differential		
De-energized	Energized	Orif. No.	Body	Stop	Body	Stop	AC	DC
2-Way Normally Closed								
		4	1/16 (1.6)		.12		750 (51.7)	750 (51.7)
		6	3/32 (2.4)		.21		500 (34.5)	500 (34.5)
		8	1/8 (3.2)		.32		300 (20.7)	300 (20.7)
		9	5/32 (4.0)		.50		225 (15.5)	225 (15.5)
		A	3/16 (4.8)		.69		140 (9.7)	140 (9.7)
		C	1/4 (6.35)		.94		100 (6.9)	100 (6.9)
		D	5/16 (8.0)		1.48		45 (3.1)	45 (3.1)
		E	3/8 (9.5)		1.90		35 (2.4)	35 (2.4)
2-Way Normally Open								
		6	3/32 (2.4)		.25		275 (19.0)	275 (19.0)
		8	1/8 (3.2)		.35		175 (12.1)	175 (12.1)
		9	5/32 (4.0)		.45		125 (8.6)	125 (8.6)
		A	3/16 (4.8)		.50		100 (6.9)	100 (6.9)
3-Way AC Pressure Ratings		Orifice Diameter		C_v Factor		Maximum Operating Pressure Differential		
De-energized	Energized	Orif. No.	Body	Stop	Body	Stop	AC	DC
3-Way Normally Closed								
LINE CONNECT								
		6	3/32 (2.4)	3/32 (2.4)	.25	.25	225 (15.5)	225 (15.5)
		8	1/8 (3.2)	1/8 (3.2)	.35	.35	150 (10.3)	150 (10.3)
		9	5/32 (4.0)	5/32 (4.0)	.45	.45	125 (8.6)	125 (8.6)
		A	3/16 (4.8)	3/16 (4.8)	.50	.50	85 (5.9)	85 (5.9)
		C	1/4 (6.35)	3/16 (4.8)	.75	.50	50 (3.4)	50 (3.4)
		D	5/16 (8.0)	3/16 (4.8)	1.10	.50	25 (1.7)	25 (1.7)
		E	3/8 (9.5)	3/16 (4.8)	1.95	.50	15 (1.0)	15 (1.0)
3-Way Normally Open								
		6	3/32 (2.4)	3/32 (2.4)	.25	.25	275 (19.0)	275 (19.0)
		8	1/8 (3.2)	1/8 (3.2)	.35	.35	175 (12.1)	175 (12.1)
		9	5/32 (4.0)	5/32 (4.0)	.45	.45	125 (8.6)	125 (8.6)
		A	3/16 (4.8)	3/16 (4.8)	.50	.50	75 (5.2)	75 (5.2)
		C	1/4 (6.35)	3/16 (4.8)	.75	.50	50 (3.4)	50 (3.4)
		D	5/16 (8.0)	3/16 (4.8)	1.10	.50	40 (2.8)	40 (2.8)
		E	3/8 (9.5)	3/16 (4.8)	1.95	.50	30 (2.1)	30 (2.1)
3-Way Directional Control								
		6	3/32 (2.4)	3/32 (2.4)	.25	.25	200 (13.8)	200 (13.8)
		8	1/8 (3.2)	1/8 (3.2)	.35	.35	175 (12.1)	175 (12.1)
		9	5/32 (4.0)	5/32 (4.0)	.45	.45	125 (8.6)	125 (8.6)
		A	3/16 (4.8)	3/16 (4.8)	.50	.50	75 (5.2)	75 (5.2)
		C	1/4 (6.35)	3/16 (4.8)	.75	.50	60 (4.1)	60 (4.1)
		D	5/16 (8.0)	3/16 (4.8)	1.10	.50	40 (2.8)	40 (2.8)
		E	3/8 (9.5)	3/16 (4.8)	1.95	.50	20 (1.4)	20 (1.4)
3-Way Multi-Purpose								
		6	3/32 (2.4)	3/32 (2.4)	.25	.25	150 (10.3)	150 (10.3)
		8	1/8 (3.2)	1/8 (3.2)	.35	.35	110 (7.6)	110 (7.6)
		9	5/32 (4.0)	5/32 (4.0)	.45	.45	75 (5.2)	75 (5.2)
		A	3/16 (4.8)	3/16 (4.8)	.50	.50	50 (3.4)	50 (3.4)
		C	1/4 (6.35)	3/16 (4.8)	.75	.50	30 (2.1)	30 (2.1)
		D	5/16 (8.0)	3/16 (4.8)	1.10	.50	15 (1.0)	15 (1.0)
		E	3/8 (9.5)	3/16 (4.8)	1.95	.50	10 (.7)	10 (.7)